



PNOZ s4.1

PILZ
THE SPIRIT OF SAFETY

► Safety relays

This document is the original document.

All rights to this documentation are reserved by Pilz GmbH & Co. KG. Copies may be made for the user's internal purposes. Suggestions and comments for improving this documentation will be gratefully received.

Source code from third-party manufacturers or open source software has been used for some components. The relevant licence information is available on the Internet on the Pilz homepage.

Pilz®, PIT®, PMI®, PNOZ®, Primo®, PSEN®, PSS®, PVIS®, SafetyBUS p®, SafetyEYE®, SafetyNET p®, the spirit of safety® are registered and protected trademarks of Pilz GmbH & Co. KG in some countries.



SD means Secure Digital

Introduction	5
Validity of documentation	5
Using the documentation	5
Definition of symbols	5
Safety	6
Intended use	6
Safety regulations	6
Safety assessment	6
Use of qualified personnel	7
Warranty and liability	7
Disposal	7
For your safety	7
Unit features	8
Safety features	8
Block diagram/terminal configuration	9
Unit types with UB 24 VDC	9
Unit types with UB 48 - 240 VAC/DC	9
Function description	10
Timing diagram	11
Installation	11
Wiring	12
Preparing for operation	13
Operating modes	13
Set operating modes	13
Connection	13
Operation	16
Status indicators	17
Error indicators	17
Faults - malfunctions	19
Dimensions in mm	19
Technical details	19
Safety characteristic data	26
Supplementary data	26
Service life graph	27
Permitted operating height	28

Remove plug-in terminals	29
Order reference	29
EC declaration of conformity	30

Introduction

Validity of documentation

This documentation is valid for the product PNOZ s4.1. It is valid until new documentation is published.

This operating manual explains the function and operation, describes the installation and provides guidelines on how to connect the product.

Using the documentation

This document is intended for instruction. Only install and commission the product if you have read and understood this document. The document should be retained for future reference.

Definition of symbols

Information that is particularly important is identified as follows:



DANGER!

This warning must be heeded! It warns of a hazardous situation that poses an immediate threat of serious injury and death and indicates preventive measures that can be taken.



WARNING!

This warning must be heeded! It warns of a hazardous situation that could lead to serious injury and death and indicates preventive measures that can be taken.



CAUTION!

This refers to a hazard that can lead to a less serious or minor injury plus material damage, and also provides information on preventive measures that can be taken.



NOTICE

This describes a situation in which the product or devices could be damaged and also provides information on preventive measures that can be taken. It also highlights areas within the text that are of particular importance.

**INFORMATION**

This gives advice on applications and provides information on special features.

Safety

Intended use

The safety relay provides a safety-related interruption of a safety circuit.

The safety relay meets the requirements of EN 60947-5-1, EN 60204-1 and VDE 0113-1 and may be used in applications with

- ▶ E-STOP pushbuttons
- ▶ Safety gates
- ▶ Light beam devices

It is suitable for use in furnaces in accordance with EN 50156-1.

The following is deemed improper use in particular

- ▶ Any component, technical or electrical modification to the product,
- ▶ Use of the product outside the areas described in this manual,
- ▶ Use of the product outside the technical details (see [Technical details](#)  19)).

**NOTICE****EMC-compliant electrical installation**

The product is designed for use in an industrial environment. The product may cause interference if installed in other environments. If installed in other environments, measures should be taken to comply with the applicable standards and directives for the respective installation site with regard to interference.

Safety regulations

Safety assessment

Before using a device it is necessary to perform a safety assessment in accordance with the Machinery Directive.

Functional safety is guaranteed for the product as a single component. However, this does not guarantee the functional safety of the overall plant/machine. In order to achieve the required safety level for the overall plant/machine, define the safety requirements for the plant/machine and then define how these must be implemented from a technical and organisational standpoint.

Use of qualified personnel

The products may only be assembled, installed, programmed, commissioned, operated, maintained and decommissioned by competent persons.

A competent person is a qualified and knowledgeable person who, because of their training, experience and current professional activity, has the specialist knowledge required. To be able to inspect, assess and operate devices, systems and machines, the person has to be informed of the state of the art and the applicable national, European and international laws, directives and standards.

It is the company's responsibility only to employ personnel who

- ▶ Are familiar with the basic regulations concerning health and safety / accident prevention,
- ▶ Have read and understood the information provided in the section entitled Safety
- ▶ Have a good knowledge of the generic and specialist standards applicable to the specific application.

Warranty and liability

All claims to warranty and liability will be rendered invalid if

- ▶ The product was used contrary to the purpose for which it is intended,
- ▶ Damage can be attributed to not having followed the guidelines in the manual,
- ▶ Operating personnel are not suitably qualified,
- ▶ Any type of modification has been made (e.g. exchanging components on the PCB boards, soldering work etc.).

Disposal

- ▶ In safety-related applications, please comply with the mission time T_M in the safety-related characteristic data.
- ▶ When decommissioning, please comply with local regulations regarding the disposal of electronic devices (e.g. Electrical and Electronic Equipment Act).

For your safety

The unit meets all the necessary conditions for safe operation. However, please note the following:

- ▶ Note for overvoltage category III: If voltages higher than low voltage (>50 VAC or >120 VDC) are present on the unit, connected control elements and sensors must have a rated insulation voltage of at least 250 V.

Unit features

- ▶ Positive-guided relay outputs:
 - 3 safety contacts (N/O), instantaneous
 - 1 auxiliary contact (N/C), instantaneous
- ▶ 1 semiconductor output
- ▶ Connection options for:
 - E-STOP pushbuttons
 - Safety gate limit switches
 - Start buttons
 - Light grids and safety switches
 - PSEN
 - Safety valves for furnaces
- ▶ A connector can be used to connect 1 PNOZsigma contact expansion module
- ▶ Operating modes can be set via rotary switch
- ▶ LED indicator for:
 - Supply voltage
 - Input status, channel 1
 - Input status, channel 2
 - Switch status of the safety contacts
 - Start circuit
 - Errors
- ▶ Plug-in connection terminals (either spring-loaded terminal or screw terminal)
- ▶ See order reference for unit types

Safety features

The safety relay meets the following safety requirements:

- ▶ The circuit is redundant with built-in self-monitoring.
- ▶ The safety function remains effective in the case of a component failure.
- ▶ The correct opening and closing of the safety function relays is tested automatically in each on-off cycle.

Block diagram/terminal configuration

Unit types with UB 24 VDC

- ▶ U_B : 24 VDC; Order no. 750124, 751124

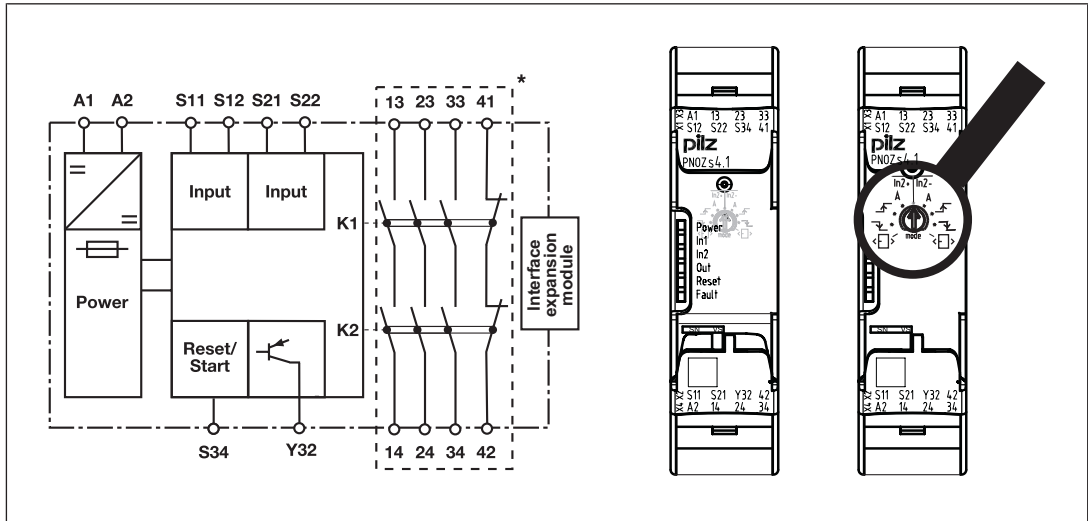

Fig.: Centre: Front view with cover, right: Front view without cover

*Insulation between the non-marked area and the relay contacts: Basic insulation (over-voltage category III), Protective separation (over-voltage category II)

Unit types with UB 48 - 240 VAC/DC

- ▶ U_B : 48 - 240 VAC/DC; Order no. 750154, 751154

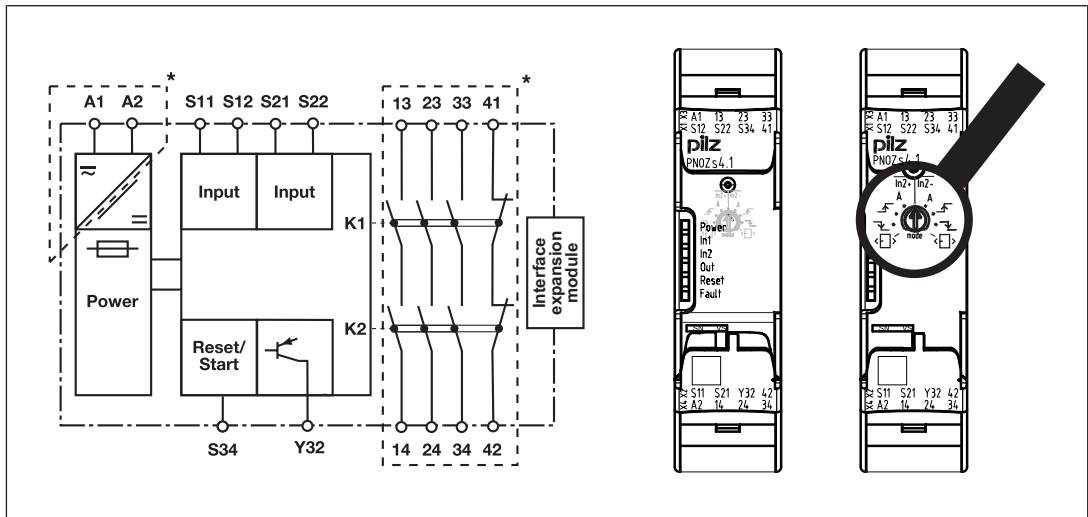







Fig.: Centre: Front view with cover, right: Front view without cover

*Insulation between the non-marked area and the relay contacts: Basic insulation (over-voltage category III), Protective separation (over-voltage category II)

Function description

- ▶  Single-channel operation: no redundancy in the input circuit, earth faults in the start circuit and input circuit are detected.
- ▶ Dual-channel operation without detection of shorts across contacts: Redundant input circuit, detects PNOZ s4.1
 - earth faults in the start and input circuit,
 - short circuits in the input circuit and, with a monitored start, in the start circuit too.
- ▶  Dual-channel operation with detection of shorts across contacts: Redundant input circuit, detects PNOZ s4.1
 - earth faults in the start and input circuit,
 - Short circuits in the input circuit and, with a monitored start, in the start circuit too,
 - Shorts across contacts in the input circuit.
- ▶ **A** Automatic start: Unit is active once the input circuit has been closed.
- ▶ Manual start Unit is active once the input circuit and the start circuit are closed.
- ▶  Monitored start with falling edge: Unit is active once
 - the input circuit is closed and then the start circuit is closed and opened again.
 - the start circuit is closed and then opened again once the input circuit is closed.
- ▶  Monitored start with rising edge: Unit is active once the input circuit is closed and once the start circuit is closed after the waiting period has elapsed (see technical details).
- ▶  Start with start-up test: The unit checks whether safety gates that are closed are opened and then closed again when supply voltage is applied.
- ▶ Increase in the number of available instantaneous safety contacts by connecting contact expander modules or external contactors/relays;
A connector can be used to connect 1 PNOZsigma contact expander module.

Timing diagram

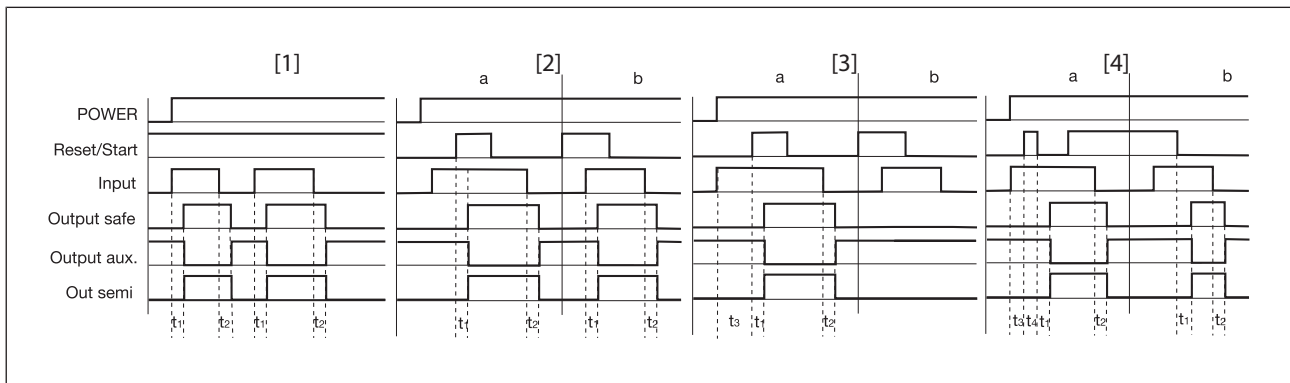

Legend

- ▶ POWER: Supply voltage
- ▶ Start: Start circuit
- ▶ Input: Input circuits
- ▶ Output safe: Safety contacts
- ▶ Output aux: Auxiliary contacts
- ▶ Out semi: Semiconductor output
- ▶ [1]: Automatic start
- ▶ [2]: Manual start
- ▶ [3]: Monitored start with rising edge
- ▶ [4]: Monitored start with falling edge
- ▶ a: Input circuit closes before start circuit
- ▶ b: Start circuit closes before input circuit
- ▶ t_1 : Switch-on delay
- ▶ t_2 : Delay-on de-energisation
- ▶ t_3 : Waiting period with a monitored start
- ▶ t_4 : Min. start pulse duration with a monitored start

Installation

Install base unit without contact expansion module:

- ▶ Ensure that the plug terminator is inserted at the side of the unit.

Connect base unit and PNOZsigma contact expansion module:

- ▶ Remove the plug terminator at the side of the base unit and at the contact expansion module.
- ▶ Connect the base unit and the contact expansion module to the supplied connector before mounting the units to the DIN rail.

Installation in control cabinet

- ▶ The safety relay should be installed in a control cabinet with a protection type of at least IP54.
- ▶ Use the notch on the rear of the unit to attach it to a DIN rail (35 mm).

- ▶ When installed vertically: Secure the unit by using a fixing element (e.g. retaining bracket or end angle).
- ▶ Push the device upwards or downwards before lifting it from the DIN rail.

Wiring

Please note:

- ▶ Information given in the "[Technical details \[19\]](#)" must be followed.
- ▶ Outputs 13-14, 23-24, 33-34 are safety contacts; output 41-42 is an auxiliary contact (e.g. for display).
- ▶ Auxiliary contact 41-42 and semiconductor output Y32 should **not** be used for safety circuits!
- ▶ To prevent contact welding, a fuse should be connected before the output contacts (see [Technical details \[19\]](#)).
- ▶ Calculation of the max. cable length l_{\max} in the input circuit:

$$l_{\max} = \frac{R_{l_{\max}}}{R_l / \text{km}}$$

$R_{l_{\max}}$ = max. overall cable resistance (see [Technical details \[19\]](#))

R_l / km = cable resistance/km

- ▶ Use copper wire that can withstand 60/75 °C.
- ▶ Sufficient fuse protection must be provided on all output contacts with capacitive and inductive loads.
- ▶ With U_b 48 – 240 VAC/DC: Connect S21 to the functional earth.
- ▶ Ensure the wiring and EMC requirements of EN 60204-1 are met.
- ▶ On 24 VDC devices:
The power supply must comply with the regulations for extra low voltages with protective electrical separation (SELV, PELV) in accordance with VDE 0100, Part 410.



NOTICE

If you connect contact expansion modules to a base unit with a universal power supply, you will need to limit the conventional thermal current at the contact expansion modules' safety contacts to 70 % of the stated current (see technical details for contact expansion module).

Preparing for operation

Operating modes

The operating mode is set via the rotary switch on the unit. You can do this by opening the cover on the front of the unit.



NOTICE

Do not adjust the rotary switch during operation, otherwise an error message will appear, the safety contacts will open and the unit will not be ready for operation until the supply voltage has been switched off and then on again.

Set operating modes

- ▶ Switch off supply voltage.
- ▶ Select operating mode via the operating mode selector switch "mode".
- ▶ If the operating mode selector switch "mode" is in its start position (vertical position), an error message will appear.

Operating mode selector switch "mode"	Automatic or manual start	Monitored start rising edge	Monitored start falling edge	Automatic start with start-up test
Without detection of shorts across contacts				
With detection of shorts across contacts				

Connection

- ▶ Supply voltage

Supply voltage	Unit types with U_B 48 - 240 VAC/DC	Unit types with U_B 24 VDC

► Input circuit

Input circuit	Single-channel	Dual-channel
E-STOP without detection of shorts across contacts		
E-STOP with detection of shorts across contacts		
Safety gate without detection of shorts across contacts		
Safety gate with detection of shorts across contacts		
Light beam device or safety switch with detection of shorts across contacts via ESPE (only when UB = 24 VDC)		



NOTICE

With single-channel wiring the safety level of your machine/plant may be lower than the safety level of the unit (see [Safety characteristic data \[26\]](#)).



NOTICE

When operated with a light grid or sensor

- It must not be possible to switch off the supply voltage for the PNOZ-sigma separately from the supply voltage for the light grid or safety switch.
- The operating mode selector switch must be set to "Without detection of shorts across contacts", as shorts across contacts are detected by the ESPE.

▶ Start circuit/feedback loop

Start circuit/feedback loop	Without feedback loop monitoring	With feedback loop monitoring
Automatic start		
Monitored, manual start/re-start		



NOTICE

In the event of an automatic start or manual start with bridged start contact (fault):

The unit starts up automatically when the safeguard is reset, e.g. when the E-STOP pushbutton is released. Use external circuit measures to prevent an unexpected restart.

▶ Semiconductor output

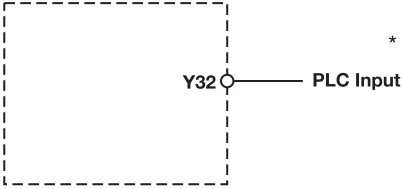
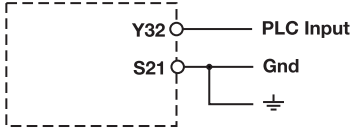

Unit types with U_B 24 VDC	Unit types with U_B 48 - 240 VAC/DC
 <p>*Connect together the 0V connections on all the external power supplies</p>	



INFORMATION

If a base unit and a contact expansion module from the PNOZsigma range are connected via the connector, no additional wiring is necessary.

Legend

- ▶ S1/S2: E-STOP/safety gate switch
- ▶ S3: Reset button
- ▶ : Switch operated
- ▶ : Gate open
- ▶ : Gate closed

Operation

When the relay outputs are switched on, the mechanical contact on the relay cannot be tested automatically. Depending on the operational environment, measures to detect the non-opening of switching elements may be required under some circumstances.

When the product is used in accordance with the European Machinery Directive, a check must be carried out to ensure that the safety contacts on the relay outputs open correctly. Open the safety contacts (switch off output) and start the device again, so that the internal diagnostics can check that the safety contacts open correctly

- ▶ for SIL CL 3/PL e at least 1x per month
- ▶ for SIL CL 2/PL d at least 1x per year





NOTICE

The safety function should be checked after initial commissioning and each time the plant/machine is changed. The safety functions may only be checked by qualified personnel.

The unit is ready for operation when the Power LED is permanently lit.

LEDs indicate the status and errors during operation:





-  LED on
-  LED flashes
-  LED off





INFORMATION

Status indicators and error indicators may occur independently. In the case of an error display, the "Fault" LED will light or flash (exception: "Supply voltage too low"). An LED that is also flashing indicates the potential cause of the error. An LED that is lit and is static indicates a normal operating status. Several status indicators and error indicators may occur simultaneously.

Status indicators

-  **POWER**
Supply voltage is present.
-  **IN1**
Input circuit at S12 is closed.
-  **IN2**
Input circuit at S22 is closed.
-  **OUT**
Safety contacts are closed and semiconductor output Y32 carries a high signal.
-  **RESET**
24 VDC is present at S34.

Error indicators

-  **All LEDs off**
Diagnostics: Short across contacts/earth fault; unit switched off
 - ▶ Remedy: Rectify short across contacts/earth fault, switch off supply voltage for 1 min.
-  **FAULT**
Diagnostics: Plug terminator not connected
 - ▶ Remedy: Insert plug terminator, switch supply voltage off and then on again.

**FAULT**

Diagnostics: Internal error, unit defective

- ▶ Remedy: Switch supply voltage off and then on again, change unit if necessary.

**POWER**

Diagnostics: Supply voltage too low

- ▶ Remedy: Check supply voltage and increase if necessary.

**IN1, IN2 alternately****FAULT**

Diagnostics: Connection error (possibly: cable resistance in the input circuit is too high) or short detected between S12 and S22

- ▶ Remedy: Rectify connection error or short across contacts, switch supply voltage off and then on again.

**IN1****FAULT**

Diagnostics: Power-up blocked due to short-term interruption at S12; input circuits not operated simultaneously

- ▶ Remedy: Open both input circuits, S12 and S22, simultaneously and then close again.

**IN2****FAULT**

Diagnostics: Power-up blocked due to short-term interruption at S22; input circuits not operated simultaneously

- ▶ Remedy: Open both input circuits, S12 and S22, simultaneously and then close again.

**RESET****FAULT**

Diagnostics: Position of rotary switch is not permitted or rotary switch was adjusted during operation.

- ▶ Remedy: Switch supply voltage off and then on again.

**POWER, IN1, IN2, OUT, RESET, FAULT**

Diagnostics: The operating mode selector switch "mode" is in its start position (vertical position)

- ▶ Remedy: Switch off the supply voltage and set the required operating mode on operating mode selector switch "mode".

Faults - malfunctions

- ▶ Contact malfunctions: If the contacts have welded, reactivation will not be possible after the input circuit has opened.

Dimensions in mm

*with spring-loaded terminals

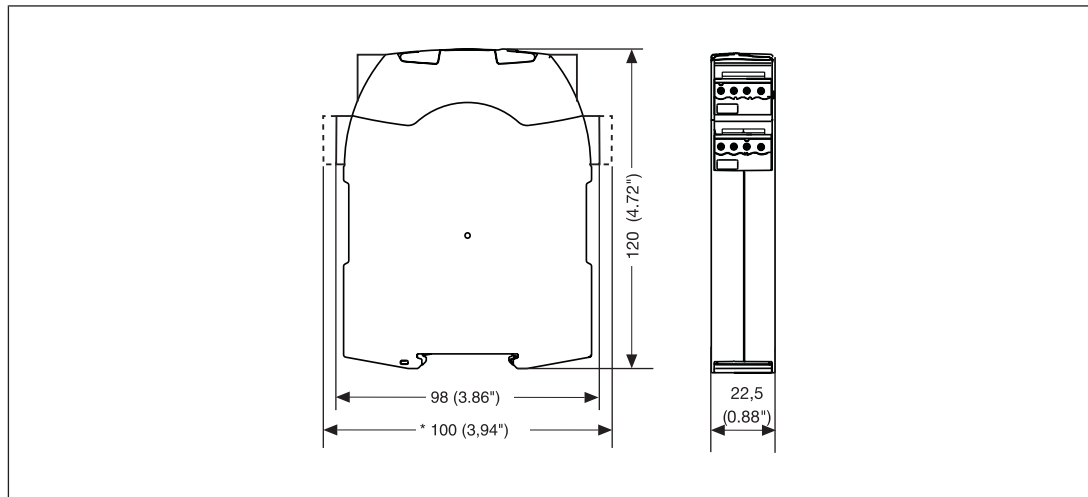

Technical details

General	750124	750154	751124	751154
Approvals	CCC, CE, EAC (Eurasian), TÜV, cULus Listed	CCC, CE, EAC (Eurasian), TÜV, cULus Listed	CCC, CE, EAC (Eurasian), TÜV, cULus Listed	CCC, CE, EAC (Eurasian), TÜV, cULus Listed
Electrical data	750124	750154	751124	751154
Supply voltage				
Voltage	24 V	48 - 240 V	24 V	48 - 240 V
Kind	DC	AC/DC	DC	AC/DC
Voltage tolerance	-15 %/+10 %	-15 %/+10 %	-15 %/+10 %	-15 %/+10 %
Output of external power supply (AC)	–	5 VA	–	5 VA
Output of external power supply (DC)	2,5 W	2,5 W	2,5 W	2,5 W
Frequency range AC	–	50 - 60 Hz	–	50 - 60 Hz
Residual ripple DC	20 %	160 %	20 %	160 %
Duty cycle	100 %	100 %	100 %	100 %
Inputs	750124	750154	751124	751154
Number	2	2	2	2

Inputs	750124	750154	751124	751154
Voltage at				
Input circuit DC	24 V	24 V	24 V	24 V
Start circuit DC	24 V	24 V	24 V	24 V
Feedback loop DC	24 V	24 V	24 V	24 V
Current at				
Input circuit DC	50 mA	50 mA	50 mA	50 mA
Start circuit DC	50 mA	50 mA	50 mA	50 mA
Feedback loop DC	50 mA	50 mA	50 mA	50 mA
Max. inrush current impulse				
Current pulse, input circuit	0,2 A	0,2 A	0,2 A	0,2 A
Pulse duration, input circuit	100 ms	100 ms	100 ms	100 ms
Current pulse, feedback loop	0,2 A	0,2 A	0,2 A	0,2 A
Pulse duration, feedback loop	15 ms	15 ms	15 ms	15 ms
Current pulse, start circuit	0,2 A	0,2 A	0,2 A	0,2 A
Pulse duration, start circuit	15 ms	15 ms	15 ms	15 ms
Max. overall cable resistance R _{lmax}				
Single-channel at UB DC	30 Ohm	30 Ohm	30 Ohm	30 Ohm
Single-channel at UB AC	–	30 Ohm	–	30 Ohm
Dual-channel without detection of shorts across contacts at UB DC	60 Ohm	60 Ohm	60 Ohm	60 Ohm
Dual-channel without detection of shorts across contacts at UB AC	–	60 Ohm	–	60 Ohm
Dual-channel with detection of shorts across contacts at UB DC	30 Ohm	30 Ohm	30 Ohm	30 Ohm
Dual-channel with detection of shorts across contacts at UB AC	–	30 Ohm	–	30 Ohm

Semiconductor outputs	750124	750154	751124	751154
Number	1	1	1	1
Voltage	24 V	24 V	24 V	24 V
Current	20 mA	20 mA	20 mA	20 mA
Relay outputs	750124	750154	751124	751154
Number of output contacts				
Safety contacts (N/O), instantaneous	3	3	3	3
Auxiliary contacts (N/C)	1	1	1	1
Max. short circuit current I _K	1 kA	1 kA	1 kA	1 kA
Utilisation category				
In accordance with the standard	EN 60947-4-1	EN 60947-4-1	EN 60947-4-1	EN 60947-4-1
Utilisation category of safety contacts				
AC1 at	240 V	240 V	240 V	240 V
Min. current	0,01 A	0,01 A	0,01 A	0,01 A
Max. current	1,5 A	1,5 A	1,5 A	1,5 A
Max. power	375 VA	375 VA	375 VA	375 VA
DC1 at	24 V	24 V	24 V	24 V
Min. current	0,01 A	0,01 A	0,01 A	0,01 A
Max. current	4 A	4 A	4 A	4 A
Max. power	100 W	100 W	100 W	100 W
Utilisation category of auxiliary contacts				
AC1 at	240 V	240 V	240 V	240 V
Min. current	0,01 A	0,01 A	0,01 A	0,01 A
Max. current	1,5 A	1,5 A	1,5 A	1,5 A
Max. power	375 VA	375 VA	375 VA	375 VA
DC1 at	24 V	24 V	24 V	24 V
Min. current	0,01 A	0,01 A	0,01 A	0,01 A
Max. current	4 A	4 A	4 A	4 A
Max. power	100 W	100 W	100 W	100 W
Utilisation category				
In accordance with the standard	EN 60947-5-1	EN 60947-5-1	EN 60947-5-1	EN 60947-5-1
Utilisation category of safety contacts				
AC15 at	230 V	230 V	230 V	230 V
Max. current	0,6 A	0,6 A	0,6 A	0,6 A
DC13 (6 cycles/min) at	24 V	24 V	24 V	24 V
Max. current	0,4 A	0,4 A	0,4 A	0,4 A

Relay outputs	750124	750154	751124	751154
Utilisation category of auxiliary contacts				
AC15 at	230 V	230 V	230 V	230 V
Max. current	0,6 A	0,6 A	0,6 A	0,6 A
DC13 (6 cycles/min) at	24 V	24 V	24 V	24 V
Max. current	0,4 A	0,4 A	0,4 A	0,4 A
Utilisation category in accordance with UL				
Voltage	240 V AC G.U. (same polarity)	240 V AC G.U. (same polarity)	240 V AC G.U. (same polarity)	240 V AC G.U. (same polarity)
With current	1,5 A	1,5 A	1,5 A	1,5 A
Voltage	24 V DC G. U.	24 V DC G. U.	24 V DC G. U.	24 V DC G. U.
With current	4 A	4 A	4 A	4 A
External contact fuse protection, safety contacts				
In accordance with the standard	EN 60947-5-1	EN 60947-5-1	EN 60947-5-1	EN 60947-5-1
Max. melting integral	66 A²s	66 A²s	66 A²s	66 A²s
Blow-out fuse, quick	4 A	4 A	4 A	4 A
Blow-out fuse, slow	3,15 A	3,15 A	3,15 A	3,15 A
Blow-out fuse, gG	4 A	4 A	4 A	4 A
Circuit breaker 24V AC/DC, characteristic B/C	3 A	3 A	3 A	3 A
External contact fuse protection, auxiliary contacts				
Max. melting integral	66 A²s	66 A²s	66 A²s	66 A²s
Blow-out fuse, quick	4 A	4 A	4 A	4 A
Blow-out fuse, slow	3,15 A	3,15 A	3,15 A	3,15 A
Blow-out fuse, gG	4 A	4 A	4 A	4 A
Circuit breaker 24 V AC/DC, characteristic B/C	3 A	3 A	3 A	3 A
Conventional thermal current	4 A	4 A	4 A	4 A
Contact material	AgCuNi + 0,2 µm Au	AgCuNi + 0,2 µm Au	AgCuNi + 0,2 µm Au	AgCuNi + 0,2 µm Au

Times	750124	750154	751124	751154
Switch-on delay				
With automatic start typ.	170 ms	170 ms	170 ms	170 ms
With automatic start max.	300 ms	300 ms	300 ms	300 ms
With automatic start after power on typ.	350 ms	350 ms	350 ms	350 ms
With automatic start after power on max.	600 ms	600 ms	600 ms	600 ms
With manual start typ.	40 ms	40 ms	40 ms	40 ms
With manual start max.	300 ms	300 ms	300 ms	300 ms
With monitored start with rising edge typ.	35 ms	35 ms	35 ms	35 ms
With monitored start with rising edge max.	50 ms	50 ms	50 ms	50 ms
With monitored start with falling edge typ.	55 ms	55 ms	55 ms	55 ms
With monitored start with falling edge max.	70 ms	70 ms	70 ms	70 ms
Delay-on de-energisation				
With E-STOP typ.	10 ms	10 ms	10 ms	10 ms
With E-STOP max.	20 ms	20 ms	20 ms	20 ms
With power failure typ.	40 ms	40 ms	40 ms	40 ms
With power failure max.	80 ms	80 ms	80 ms	80 ms
Recovery time at max. switching frequency 1/s				
After E-STOP	50 ms	50 ms	50 ms	50 ms
After power failure	100 ms	100 ms	100 ms	100 ms
Waiting period with a monitored start				
With rising edge	120 ms	120 ms	120 ms	120 ms
With falling edge	250 ms	150 ms	250 ms	150 ms
Min. start pulse duration with a monitored start				
With rising edge	30 ms	30 ms	30 ms	30 ms
With falling edge	100 ms	100 ms	100 ms	100 ms

Times	750124	750154	751124	751154
Supply interruption before de-energisation	20 ms	20 ms	20 ms	20 ms
Simultaneity, channel 1 and 2 max.	∞	∞	∞	∞
Environmental data	750124	750154	751124	751154
Climatic suitability	EN 60068-2-78	EN 60068-2-78	EN 60068-2-78	EN 60068-2-78
Ambient temperature				
Temperature range	-10 - 60 °C	-10 - 60 °C	-10 - 60 °C	-10 - 60 °C
Storage temperature				
Temperature range	-40 - 85 °C	-40 - 85 °C	-40 - 85 °C	-40 - 85 °C
Climatic suitability				
Humidity	93 % r. h. at 40 °C	93 % r. h. at 40 °C	93 % r. h. at 40 °C	93 % r. h. at 40 °C
Condensation during operation	Not permitted	Not permitted	Not permitted	Not permitted
EMC	EN 60947-5-1, EN 61000-6-2, EN 61000-6-4, EN 61326-3-1	EN 60947-5-1, EN 61000-6-2, EN 61000-6-4, EN 61326-3-1	EN 60947-5-1, EN 61000-6-2, EN 61000-6-4, EN 61326-3-1	EN 60947-5-1, EN 61000-6-2, EN 61000-6-4, EN 61326-3-1
Vibration				
In accordance with the standard	EN 60068-2-6	EN 60068-2-6	EN 60068-2-6	EN 60068-2-6
Frequency	10 - 150 Hz	10 - 150 Hz	10 - 150 Hz	10 - 150 Hz
Amplitude	0,35 mm	0,35 mm	0,35 mm	0,35 mm
Airgap creepage				
In accordance with the standard	EN 60947-1	EN 60947-1	EN 60947-1	EN 60947-1
Overvoltage category	III / II	III / II	III / II	III / II
Pollution degree	2	2	2	2
Rated insulation voltage	250 V	250 V	250 V	250 V
Rated impulse withstand voltage	4 kV	4 kV	4 kV	4 kV
Protection type				
Housing	IP40	IP40	IP40	IP40
Terminals	IP20	IP20	IP20	IP20
Mounting area (e.g. control cabinet)	IP54	IP54	IP54	IP54
Mechanical data	750124	750154	751124	751154
Mounting position	Any	Any	Any	Any
Mechanical life	10,000,000 cycles	10,000,000 cycles	10,000,000 cycles	10,000,000 cycles

Mechanical data	750124	750154	751124	751154
Material				
Bottom	PC	PC	PC	PC
Front	PC	PC	PC	PC
Top	PC	PC	PC	PC
Connection type	Screw terminal	Screw terminal	Spring-loaded terminal	Spring-loaded terminal
Mounting type	plug-in	plug-in	plug-in	plug-in
Conductor cross section with screw terminals				
1 core flexible	0,25 - 2,5 mm², 24 - 12 AWG	0,25 - 2,5 mm², 24 - 12 AWG	–	–
2 core with the same cross section, flexible with crimp connectors, no plastic sleeve	0,25 - 1 mm², 24 - 16 AWG	0,25 - 1 mm², 24 - 16 AWG	–	–
2 core with the same cross section, flexible without crimp connectors or with TWIN crimp connectors	0,2 - 1,5 mm², 24 - 16 AWG	0,2 - 1,5 mm², 24 - 16 AWG	–	–
Torque setting with screw terminals	0,5 Nm	0,5 Nm	–	–
Conductor cross section with spring-loaded terminals: Flexible with/without crimp connector	–	–	0,2 - 2,5 mm², 24 - 12 AWG	0,2 - 2,5 mm², 24 - 12 AWG
Spring-loaded terminals: Terminal points per connection	–	–	2	2
Stripping length with spring-loaded terminals	–	–	9 mm	9 mm
Dimensions				
Height	98 mm	98 mm	100 mm	100 mm
Width	22,5 mm	22,5 mm	22,5 mm	22,5 mm
Depth	120 mm	120 mm	120 mm	120 mm
Weight	190 g	210 g	185 g	210 g

Where standards are undated, the 2017-01 latest editions shall apply.

Safety characteristic data



NOTICE
 You must comply with the safety characteristic data in order to achieve the required safety level for your plant/machine.

Operating mode	EN ISO 13849-1: 2015 PL	EN ISO 13849-1: 2015 Category	EN 62061 SIL CL	EN 62061 PFH _D [1/h]	IEC 61511 SIL	IEC 61511 PFD	EN ISO 13849-1: 2015 T _M [year]
----------------	----------------------------	----------------------------------	--------------------	------------------------------------	------------------	------------------	---

Safety contacts, instantaneous

PL e	Cat. 4	SIL CL 3	2,31E-09	SIL 3	2,03E-06	20
------	--------	----------	----------	-------	----------	----

All the units used within a safety function must be considered when calculating the safety characteristic data.



INFORMATION
 A safety function's SIL/PL values are **not** identical to the SIL/PL values of the units that are used and may be different. We recommend that you use the PAscal software tool to calculate the safety function's SIL/PL values.

Supplementary data



CAUTION!
 It is essential to consider the relay's service life graphs. The relay outputs' safety-related characteristic data is only valid if the values in the service life graphs are met.

The PFH value depends on the switch frequency and the load of the relay output. If the service life graphs are not accessible, the stated PFH value can be used irrespective of the switch frequency and the load, as the PFH value already considers the relay's B10d value as well as the failure rates of the other components.

Service life graph

The service life graphs indicate the number of cycles from which failures due to wear must be expected. The wear is mainly caused by the electrical load; the mechanical load is negligible.

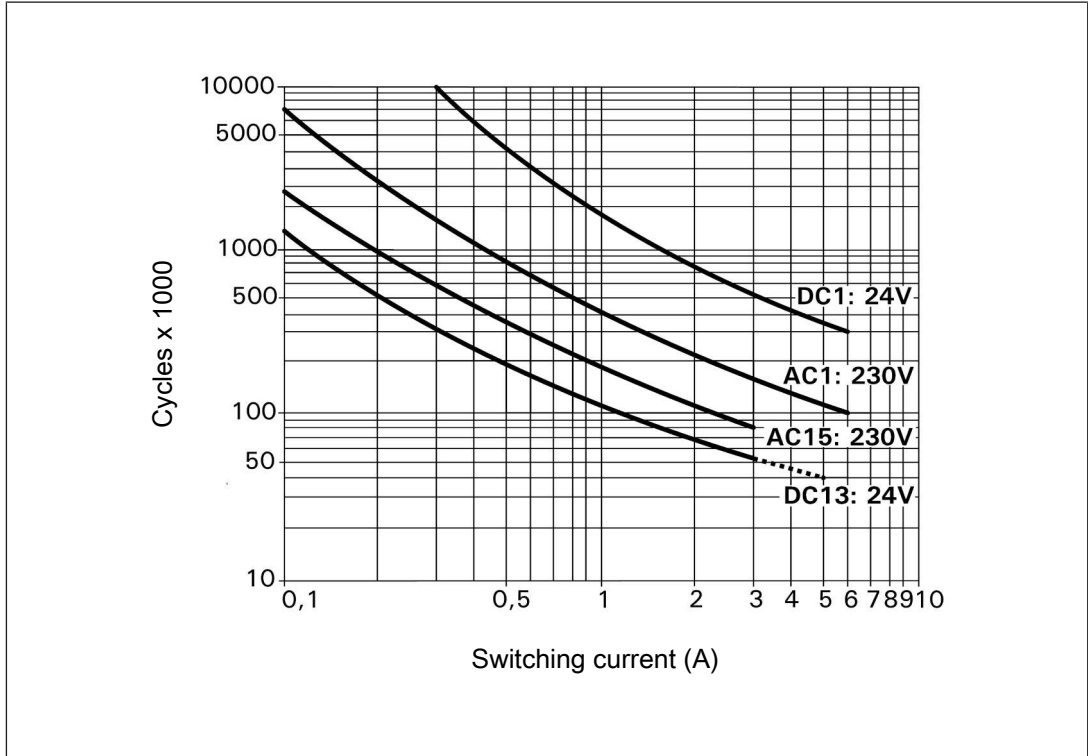

Fig.: Service life graphs at 24 V DC and 230 V AC

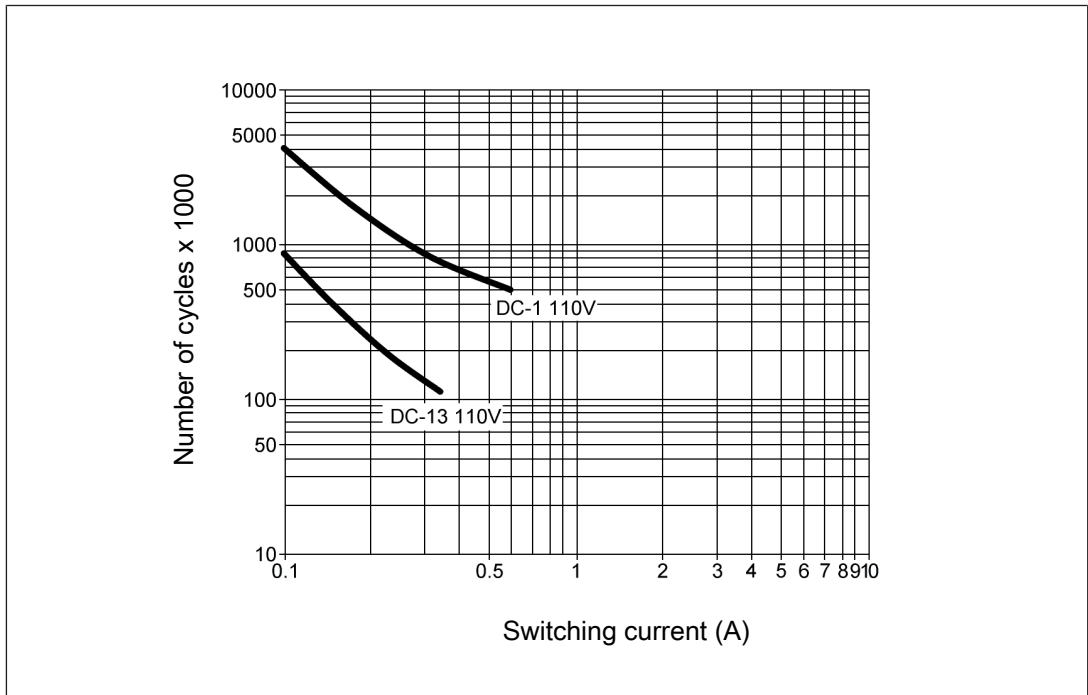

Fig.: Service life graphs at 110 V DC

Example

- ▶ Inductive load: 0.2 A
- ▶ Utilisation category: AC15
- ▶ Contact service life: 1 000 000 cycles

Provided the application to be implemented requires fewer than 1 000 000 cycles, the PFH value (see [Technical details \[19\]](#)) can be used in the calculation.

To increase the service life, sufficient spark suppression must be provided on all relay contacts. With capacitive loads, any power surges that occur must be noted. With DC contactors, use flywheel diodes for spark suppression.

Permitted operating height

The values stated in the technical details apply to the use of the device in operating heights up to max. 2000 m above sea level. When used in greater heights, constraints have to be taken into account:

- ▶ Permitted maximum operating height 5000 m
- ▶ Only device versions with UB 24 V DC are permitted (order no. 750124, 751124)
- ▶ Reduction of rated insulation voltage and rated impulse withstand voltage for applications with safe separation:

Maximum operation height	Rated insulation voltage	Overvoltage category	Max. rated impulse withstand voltage
3000 m	150 V	II	2.5 kV
	100 V	III	2.5 kV
4000 m	150 V	II	2.5 kV
	100 V	III	2.5 kV
5000 m	100 V	II	1.5 kV
	24 V	III	0.8 kV

- ▶ Reduction of rated insulation voltage and rated impulse withstand voltage for applications with basic insulation:

Maximum operation height	Rated insulation voltage	Overvoltage category	Max. rated impulse withstand voltage
3000 m	250 V	II	2.5 kV
	150 V	III	2.5 kV
4000 m	250 V	II	2.5 kV
	150 V	III	2.5 kV
5000 m	150 V	II	1.5 kV
	100 V	III	1.5 kV

- ▶ From an operating height of 2000 m the max. permitted ambient temperature is reduced by 0.5 °C/100 m

Operating height	Permitted ambient temperature
3000 m	50 °C
4000 m	45 °C
5000 m	40 °C

Remove plug-in terminals

Procedure: Insert the screwdriver into the housing recess behind the terminal and lever the terminal out.

Do **not** remove the terminals by pulling the cables!

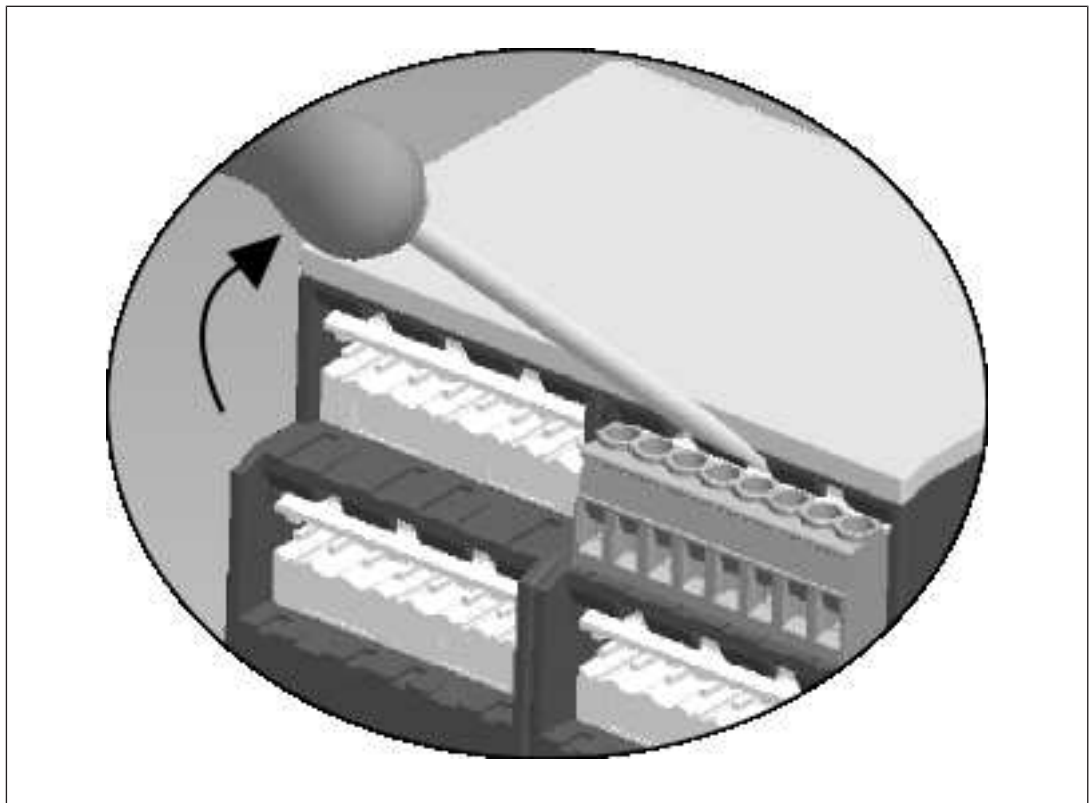

Order reference

Product type	Features	Connection type	Order no.
PNOZ s4.1	24 VDC	Screw terminals	750 124
PNOZ s4.1 C	24 VDC	Spring-loaded terminal	751 124
PNOZ s4.1	48 - 240 V AC/DC	Screw terminals	750 154
PNOZ s4.1 C	48 - 240 V AC/DC	Spring-loaded terminals	751 154

EC declaration of conformity

This product/these products meet the requirements of the directive 2006/42/EC for machinery of the European Parliament and of the Council. The complete EC Declaration of Conformity is available on the Internet at www.pilz.com/downloads.

Authorised representative: Norbert Fröhlich, Pilz GmbH & Co. KG, Felix-Wankel-Str. 2, 73760 Ostfildern, Germany